

PROJETO DRENAGEM

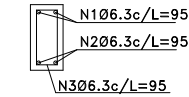

LEGENDA

- | | | | | | | | |
|--|-----------------------|--|------------------------|--|---------------------|--|----------------------------|
| | CURVA DE NIVEL | | PERFIL DO TERRENO | | CERCA | | RM RESIDÊNCIA EM MADEIRA |
| | CURSO D'ÁGUA | | BORDO DE TERRAPLANAGEM | | MURO | | RA RESIDÊNCIA EM ALVENARIA |
| | BUEIRO EXISTENTE | | OFFSET DE ATERRO | | BOCA DE LOBO | | CR CONSTRUÇÃO RURAL |
| | EIXO PROJETADO | | OFFSET DE CORTE | | BUEIRO PROJETADO | | POSTE |
| | BORDO PROJETADO | | TALUDE DE CORTE | | SARJETA EM CONCRETO | | VEGETAÇÃO 1 |
| | ACOSTAMENTO PROJETADO | | TALUDE DE ATERRO | | BOCA DE BUEIRO | | VEGETAÇÃO RASTEIRA |
| | GRADE PROJETADO | | PISTA PAVIMENTADA | | DRENO PROFUNDO | | LAVOURA |

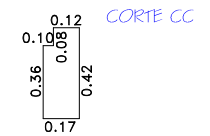
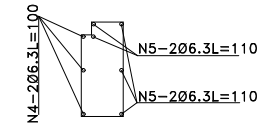
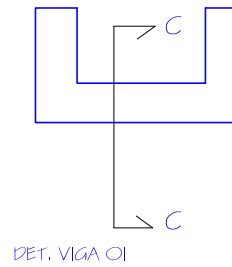
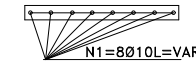
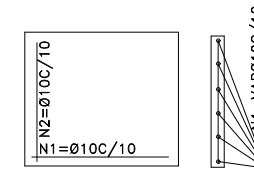
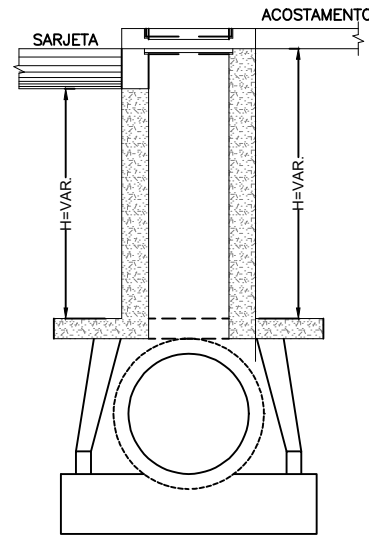
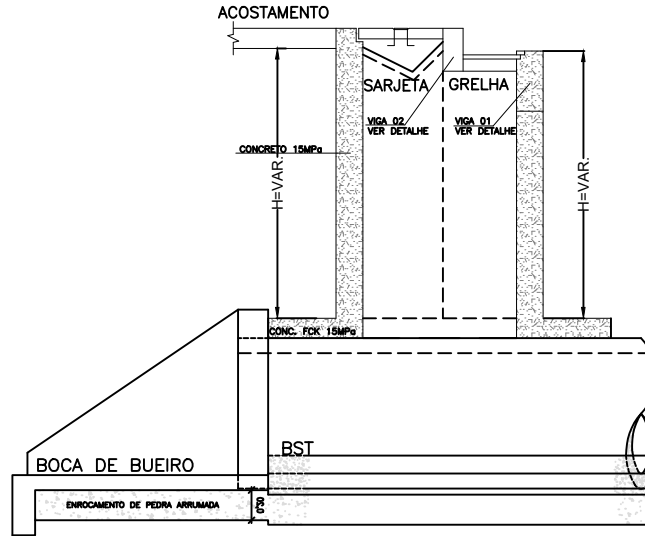
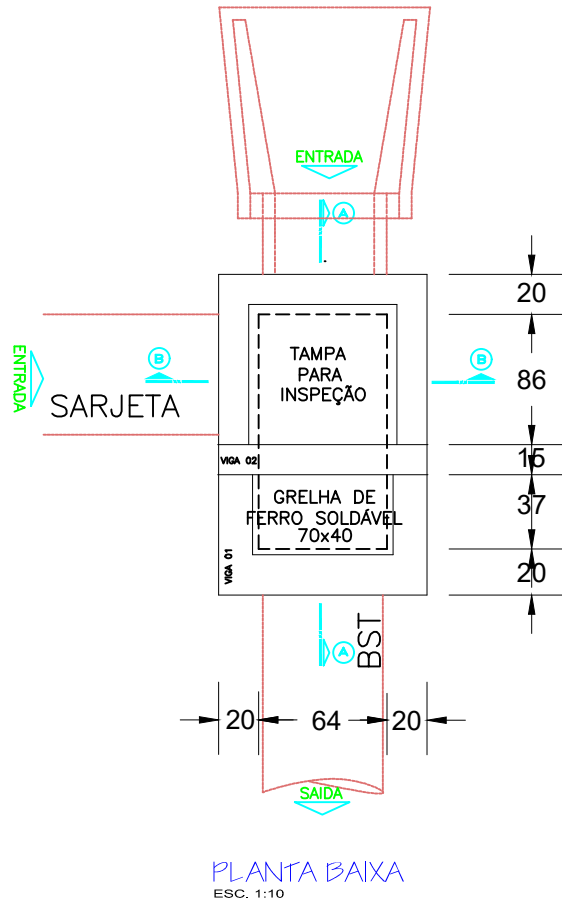

TÍTULO: PAVIMENTAÇÃO RODOVIA LINHA SANTO ALÉCIO (TRECHO 02)	
REFERÊNCIA: PROJETO EXECUTIVO	DETALHE CAIXA COLETORA TIPO 01
PRANCHAS:	
PROPRIETÁRIO: MUNICÍPIO DE IBIAM	21
RESPONSÁVEL TÉCNICO: RONALDO REGALIN - ENGENHEIRO CIVIL	
ESCALA: SEM ESCALA	DATA: MAIO/2020